

## Attachment A

" Shielding of the West Booster Tower Building from the Radiation Arising from the Operational losses of 8 GeV proton Beam at the Booster Extraction Region during Main Injector Era",

C.M. Bhat and P. Martin (May 1996)

# Radiation Shielding of the West Booster Tower Building from the Radiation Arising from the Operational losses at the Booster Extraction Region during Main Injector Era.

C.M. Bhat and P. Martin

Fermi National Accelerator Laboratory

P.O. Box 500, Batavia, Illinois 60510\*

Jan. 26, 1995, Revised on May 1996

The primary motivation of this study is to investigate a scheme to shield the West Booster Tower from the radiation due to the 8GeV proton beam loss at the Booster to Main Injector extraction region during the normal operational conditions. Previously it has been planned ( Ref. 1) to shield this region by making a major excavation under the West Booster Tower. Excavating and piling up about 4ft to 5ft of steel under the building without affecting the building will be a challenge for civil construction and as well as will be considerably expensive to the Main Injector project. Here we are proposing an alternative but a cost effective method.

Following assumptions will go into our radiation shielding calculations:

- 1 ft of steel shielding adds a soil equivalent of 2.89ft.
- 1 ft of heavy concrete shielding has a soil equivalent of 1.5ft.
- An operational loss of  $2.0E11p@8GeV/sec$  at the Lambertson (i.e.  $7.2E14p/hour$ )
- An accidental loss of  $5.7E16p@8GeV/accident$  (Ref 2)

The operational loss mentioned above is a significant fraction of the average operational loss described in PSAR (Ref. 2). A beam loss of  $1E19p@8GeV/year$  is estimated in PSAR. Assuming an average operational period as 6000 hours/year, the loss per hour is  $1.67E15p$ . In the present case we have assumed that for every Booster batch of  $5E12p@8GeV$  with 84 bunches, about  $6E10$  protons will be lost at Lambertson alone. With a maximum of 6 booster batch in 1.8sec, this beam loss will be about 43% of the total operational loss as mentioned in PSAR.

For determining the amount of shielding required following guide lines have been considered :

- The necessary shielding for 8GeV beam line enclosure is 24.5ft of earth equivalent (Ref. 2). Or, radiation level less than 0.025 mrem/hour for normal operational losses

and/or less than 1 mrem/accident for accidental beam losses ( no precaution needed and no occupancy limit ) (Ref. 3)

Under the West Booster Tower, the 8 GeV beam line tunnel takes two wings. One is for Booster Ring and another is for 8 GeV beam line leading to MI. Presently this is called AP4 beam line. Fig. 1 and 2 show plan view and the cross-sectional view of this region respectively. Under the West Booster Tower building a significant area has been covered by 3.5ft thick heavy concrete. The heavy concrete used here is 1.55 times denser than the normal concrete. This has about 78% of normal concrete and 22% of steel( Ref. 4). Because of the density difference between normal concrete and heavy concrete we assume that 1ft of heavy concrete is equivalent to 1.5ft of normal concrete (or soil). Besides there is a concrete arched pipe of 5ft dia, to let the water to go out of Booster pond.

The Booster beam is at an elevation of 726.582ft (with tunnel ceiling at 730.5 ft) and the floor of the West Booster Tower is at an elevation of 744ft. Thus, there is only a total shielding of about **15.52ft soil equivalent including the heavy concrete**. Hence, we need a minimum of additional 9.25ft soil equivalent shielding material between floor of the West Booster Tower and the Beam line to meet the PSAR requirements. Here we investigate a possibility of adding steel on the top of the Lambertson to reduce the radiation levels in and around the West Booster Tower Building to an acceptable limit.

The geometry of the tunnel with Lambertson and other utilities is very complicated. The maximum vertical space between tunnel ceiling and the body of the Lambertson is only 3.2ft. Besides this vertical spacing varies from location to location as we go down stream of the beam line. To estimate the required shielding thickness we did Monte Carlo calculations using CASIM ( Ref. 5) with cylindrical geometry. By this we could estimate radiation level at the surface for different shielding thicknesses of iron. To include the exact three dimensional geometry of the whole region we used a separate computer program which uses 24.5ft soil equivalent as a constraint. Of course, the same thing can be done with the program CASIM. The primary problem in using CASIM for such complicated geometry will be with high statistics needed for reliable calculations and a large computation time.

The results of CASIM calculations for the cases investigated here are listed in the Table I. The Fig. 3 shows contours of equal star densities from CASIM for this region without any additional shielding. This gives 15mrem/hour under normal operating conditions. If we fill up the entire gap between Lambertson and the tunnel roof with steel, i.e. with about 3ft steel and about 2.4 in clearance, we will be able to add a maximum shielding of 8.67ft soil equivalent. Fig. 4 shows results of CASIM calculations for 3ft of iron above the Lambertson and we estimate about 0.04 mrem/hour for operational losses. This gives an adequate shielding only for no occupancy limit.

sign ('Caution' Radiologically Controlled Area ) in the Booster tower. For accidental beam losses we expect about 3 mrem/acc.

The void due the arched pipe under the West Booster Tower adds to shielding deficit at some regions in the Building. This can be overcome by extending the steel shielding to about another 6 ft downstream of the Lambertson. Fig. 5a and 5b show results obtained with exact geometry which support the results obtained by using CASIM. The Fig. 5b shows the results for three different shielding widths viz., 4ft, 3ft and 2.5ft ( with a 2ft wide Lambertson) with a maximum thickness of 3ft. From this we find that 3.0ft thick, 3ft wide and 13ft long steelshielding above the Lambertson will give a soil equivalent shielding of 26ft ( including the thickness of the Lambertson Iron). If the thickness of the Lambertson is not included then we find that soil equivalent is only 23.9ft. Hence the area right above the Lambertson will be under shielded both for normal as well as accidental losses if no other precaution is taken. However, the radiation level in the West Booster tower falls rapidly as we go down stream of the beam line as shown in Figs. 6. A possible solution to protect right above the Lambertson is, to use interlocked detectors in the vicinity of the Lambertson and other places. This method of shielding reduces cost of civil construction considerably.

## Summary

We have estimated the radiation level at the surface near West Booster Tower arising due to losses of about  $2E11p@8GeV/sec$  at the extraction Lambertson from Booster to MI as 15mrem/hour. This can be brought down to 0.04mrem/hour by adding about 13ftX3ftX3ft steel block above the Lambertson. For accidental beam losses the radiation level can be brought down to 3 mrem/acc. This requires posting of signs as "Caution - Radiation Area" . For unlimited occupancy for accidental beam losses we will require interlocked detectors with trip levels set properly so that the total radiation will not be in excess of 1 mrem/hour(Ref. 3).

We would like to thank A. Leveling, A. Van Ginneken and N. Mokhov for their useful comments.

## References

1. Title I Design Report Fermilab Main Injector 1992
2. Fermilab Main Injector Preliminary Safety Analysis Report, 1992
3. Fermilab Radiological Control Manual
4. Tom Pawlak (Private communication 1994).
5. A. Van Ginneken, CASIM code.

Table I. Comparison of the expected radiation as a function of thickness of the steel-stacked over the Lambertson. Operational beam loss is taken to be  $2E11p@8GeV/sec$ . This is about 43% of the total operational beam loss set by PSAR. Accidental beam loss is  $5.7E16p@8GeV/accident$ . The star densities have been evaluated using CASIM with cylindrical geometry.

Location	Different Scenario	Number of Stars/cc/p@8GeV	Radiation/p loss (rem)	Total radiation (mrem/hour)
744ft Elevation 'A' in Fig.2, Worst Scenario	Without Shielding	2E-12	2E-17	15 ( Operational loss) 1140 ( Accidental loss)
	2ft of iron	1E-13	1E-18	.7 ( Operational loss) 57 ( Accidental loss)
	3ft of iron	5E-15	5E-20	0.04 ( Operational loss) 3 ( Accidental loss)
Booster Gallery 'B' in Fig.2.	Without Shielding	6E-14	6E-19	.5 ( Operational loss) 40 ( Accidental loss)
	2ft of iron	1E-14	1E-19	.07 (Operational loss) 6 ( Accidental loss)
	3ft of iron	1.5E-16	1.5E-21	.0015 ( Operational loss) 0.15 ( Accidental loss)

## Standard Fermilab Geometry for the $p\bar{b}$ Target and $p\bar{b}$ Collection System

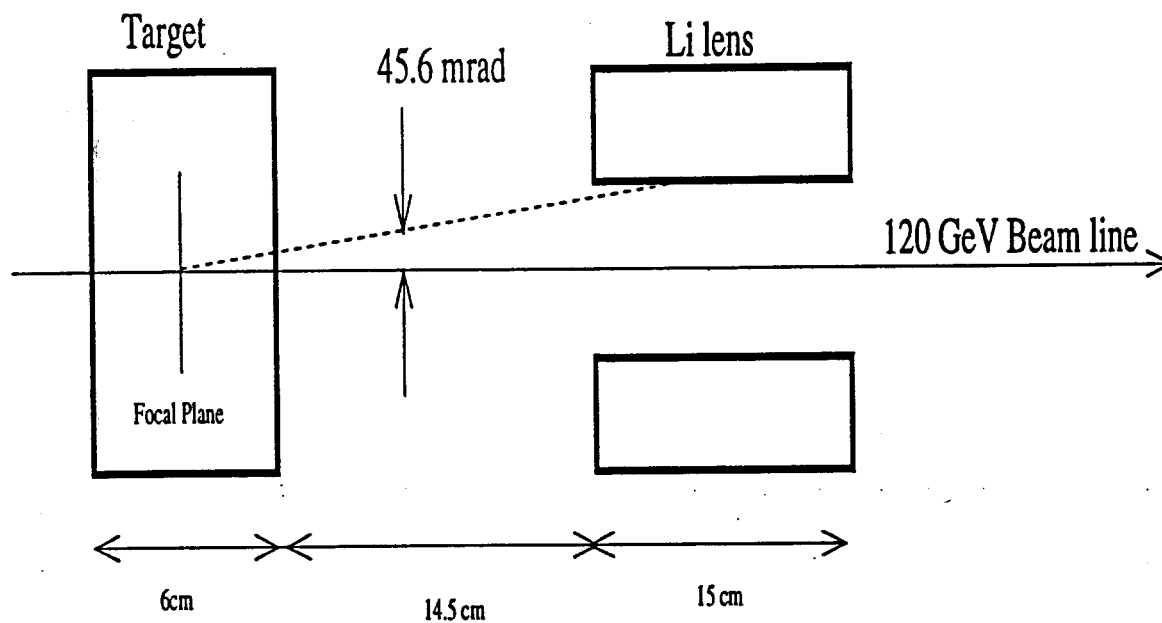

Figure 2: A schematic view of the  $p\bar{b}$  collection system. The 8 GeV  $p\bar{b}$  bending magnet is not shown.

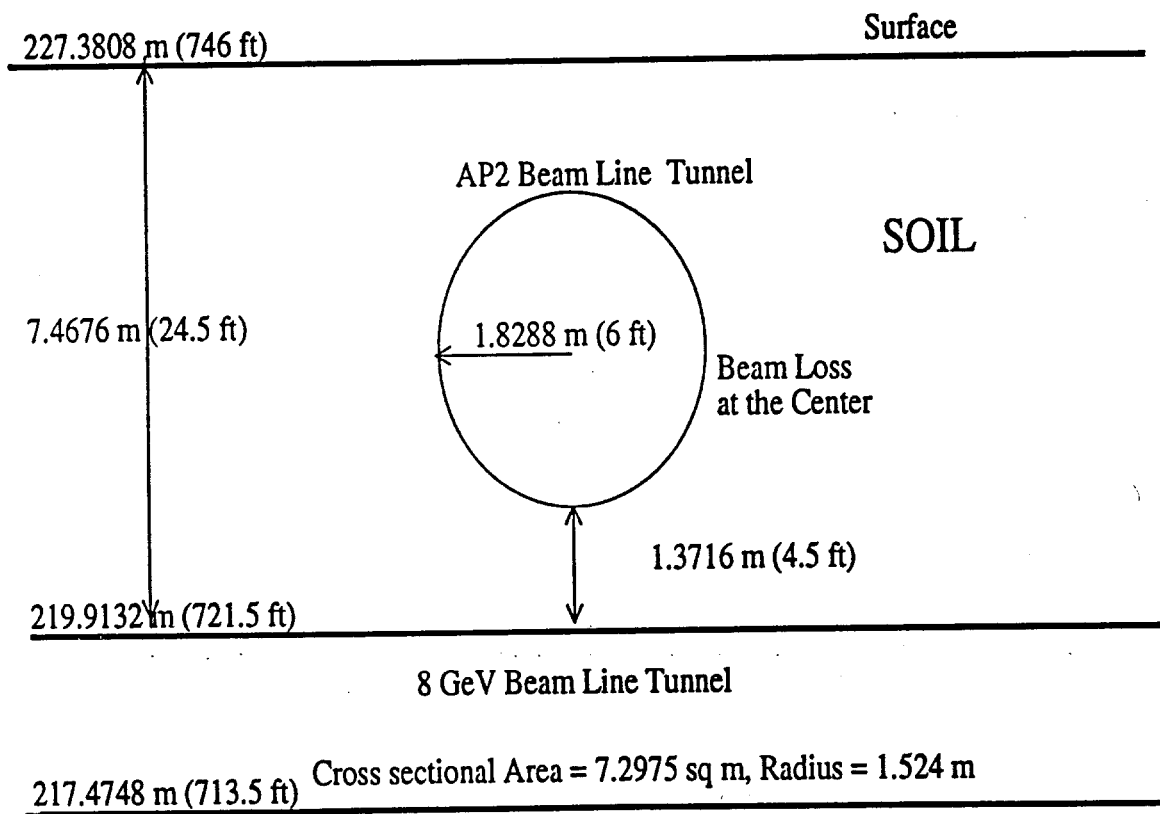

Figure 3: Geometry used in the Monte Carlo calculations to estimate the radiation dose in 8 GeV beam line tunnel due to an accidental beam loss in the AP2/AP3 beam line.

Radiation Dose in the 8GeV Beamline due to  
Accidental Beamlosses in the AP2/AP3 Beamline (CASPEN)  
(Direction of the Beams: pbar target to Debuncher ring)

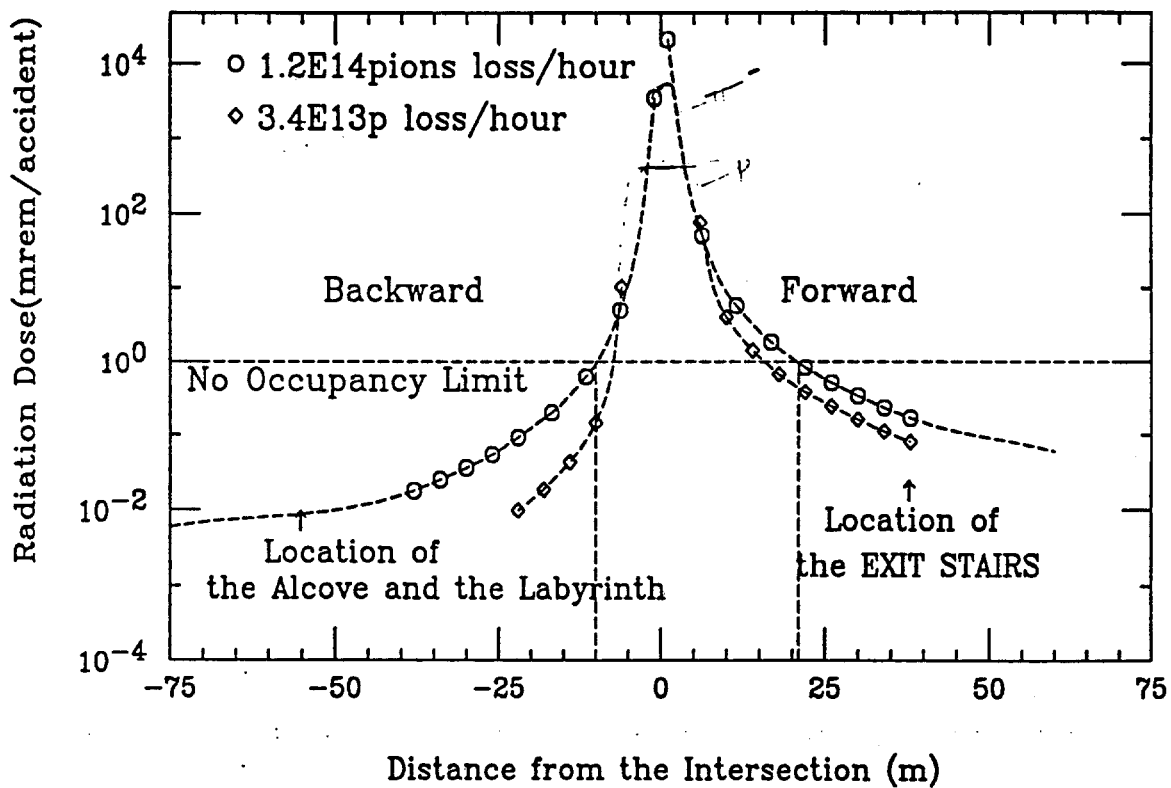
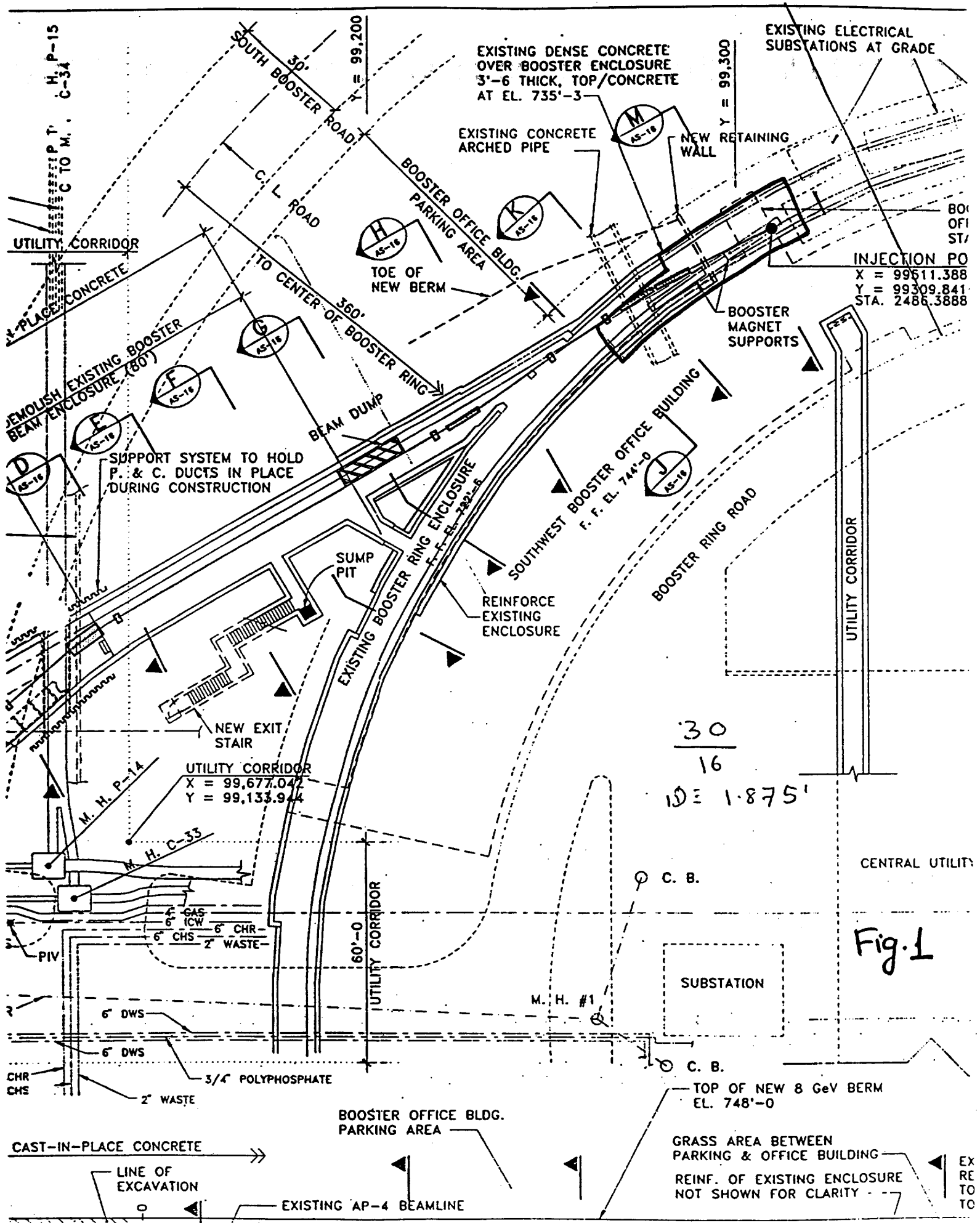

Figure 4: Results of the Monte Carlo calculations with computer code CASPEN for protons and pions. The locations of the EXITs (from the 8 GeV beam-line) which are on the both sides of the intersections are indicated by arrows. The origin is the point of intersection of two beam lines.





EXISTING DENSE CONCRETE OVER BOOSTER ENCLOSURE 3'-6 THICK, TOP/CONCRETE AT EL. 735'-3

EXISTING ELECTRICAL SUBSTATIONS AT GRADE

EXISTING CONCRETE ARCHED PIPE

NEW RETAINING WALL

INJECTION POINT  
 X = 99511.388  
 Y = 99309.841  
 STA. 2486.3888

UTILITY CORRIDOR

REMOVE EXISTING BOOSTER BEAM ENCLOSURE (80')

SUPPORT SYSTEM TO HOLD P. & C. DUCTS IN PLACE DURING CONSTRUCTION

BEAM DUMP

EXISTING BOOSTER RING ENCLOSURE  
 F.F. EL. 732'-6

SOUTHWEST BOOSTER OFFICE BUILDING  
 F.F. EL. 744'-0

REINFORCE EXISTING ENCLOSURE

BOOSTER RING ROAD

SUMP PIT

NEW EXIT STAIR

UTILITY CORRIDOR  
 X = 99,677.047  
 Y = 99,133.944

$\frac{30}{16}$

$D = 1.875'$

CENTRAL UTILITY

Fig. 1

C. B.

SUBSTATION

M. H. #1

C. B.

TOP OF NEW 8 GeV BERM  
 EL. 748'-0

GRASS AREA BETWEEN PARKING & OFFICE BUILDING

REINF. OF EXISTING ENCLOSURE NOT SHOWN FOR CLARITY

EX RE TO TO

CAST-IN-PLACE CONCRETE

LINE OF EXCAVATION

EXISTING AP-4 BEAMLINE

BOOSTER OFFICE BLDG. PARKING AREA

6" DWS  
 6" DWS  
 CHR  
 3/4" POLYPHOSPHATE  
 2" WASTE

6" GAS  
 6" ICW  
 6" CHS  
 2" WASTE  
 PIV

M. H. P-14  
 M. H. C-35

UTILITY CORRIDOR

SOUTH BOOSTER ROAD  
 30'  
 C. L. ROAD  
 TO CENTER OF BOOSTER RING  
 360'

H. P-15  
 C TO M. C-34

Y = 99,300

Y = 99,200

UTILITY CORRIDOR

REMOVE EXISTING BOOSTER BEAM ENCLOSURE (80')

SUPPORT SYSTEM TO HOLD P. & C. DUCTS IN PLACE DURING CONSTRUCTION

BEAM DUMP

EXISTING BOOSTER RING ENCLOSURE  
 F.F. EL. 732'-6

SOUTHWEST BOOSTER OFFICE BUILDING  
 F.F. EL. 744'-0

REINFORCE EXISTING ENCLOSURE

BOOSTER RING ROAD

SUMP PIT

NEW EXIT STAIR

UTILITY CORRIDOR  
 X = 99,677.047  
 Y = 99,133.944

$\frac{30}{16}$

$D = 1.875'$

CENTRAL UTILITY

Fig. 1

C. B.

SUBSTATION

M. H. #1

C. B.

TOP OF NEW 8 GeV BERM  
 EL. 748'-0

GRASS AREA BETWEEN PARKING & OFFICE BUILDING

REINF. OF EXISTING ENCLOSURE NOT SHOWN FOR CLARITY

EX RE TO TO

CAST-IN-PLACE CONCRETE

LINE OF EXCAVATION

EXISTING AP-4 BEAMLINE

BOOSTER OFFICE BLDG. PARKING AREA

6" DWS  
 6" DWS  
 CHR  
 3/4" POLYPHOSPHATE  
 2" WASTE

6" GAS  
 6" ICW  
 6" CHS  
 2" WASTE  
 PIV

M. H. P-14  
 M. H. C-35

UTILITY CORRIDOR

SOUTH BOOSTER ROAD  
 30'  
 C. L. ROAD  
 TO CENTER OF BOOSTER RING  
 360'

H. P-15  
 C TO M. C-34

Y = 99,300

Y = 99,200

UTILITY CORRIDOR

REMOVE EXISTING BOOSTER BEAM ENCLOSURE (80')

SUPPORT SYSTEM TO HOLD P. & C. DUCTS IN PLACE DURING CONSTRUCTION

BEAM DUMP

EXISTING BOOSTER RING ENCLOSURE  
 F.F. EL. 732'-6

SOUTHWEST BOOSTER OFFICE BUILDING  
 F.F. EL. 744'-0

REINFORCE EXISTING ENCLOSURE

BOOSTER RING ROAD

SUMP PIT

NEW EXIT STAIR

UTILITY CORRIDOR  
 X = 99,677.047  
 Y = 99,133.944

$\frac{30}{16}$

$D = 1.875'$

CENTRAL UTILITY

Fig. 1

C. B.

SUBSTATION

M. H. #1

C. B.

TOP OF NEW 8 GeV BERM  
 EL. 748'-0

GRASS AREA BETWEEN PARKING & OFFICE BUILDING

REINF. OF EXISTING ENCLOSURE NOT SHOWN FOR CLARITY

EX RE TO TO

REV.	DESCRIPTION
A	ADDED REDLINE ASSIGNED NUMBER
	J. DEWANEY

L-3 SEPTUM / UTILITY TUNNEL  
BR03

- REFERENCES  
 5-1-1-PS-2  
 5-1-1-PS-3  
 5-1-1-PS-4  
 5-1-1-PS-5  
 5-1-18-SC-7

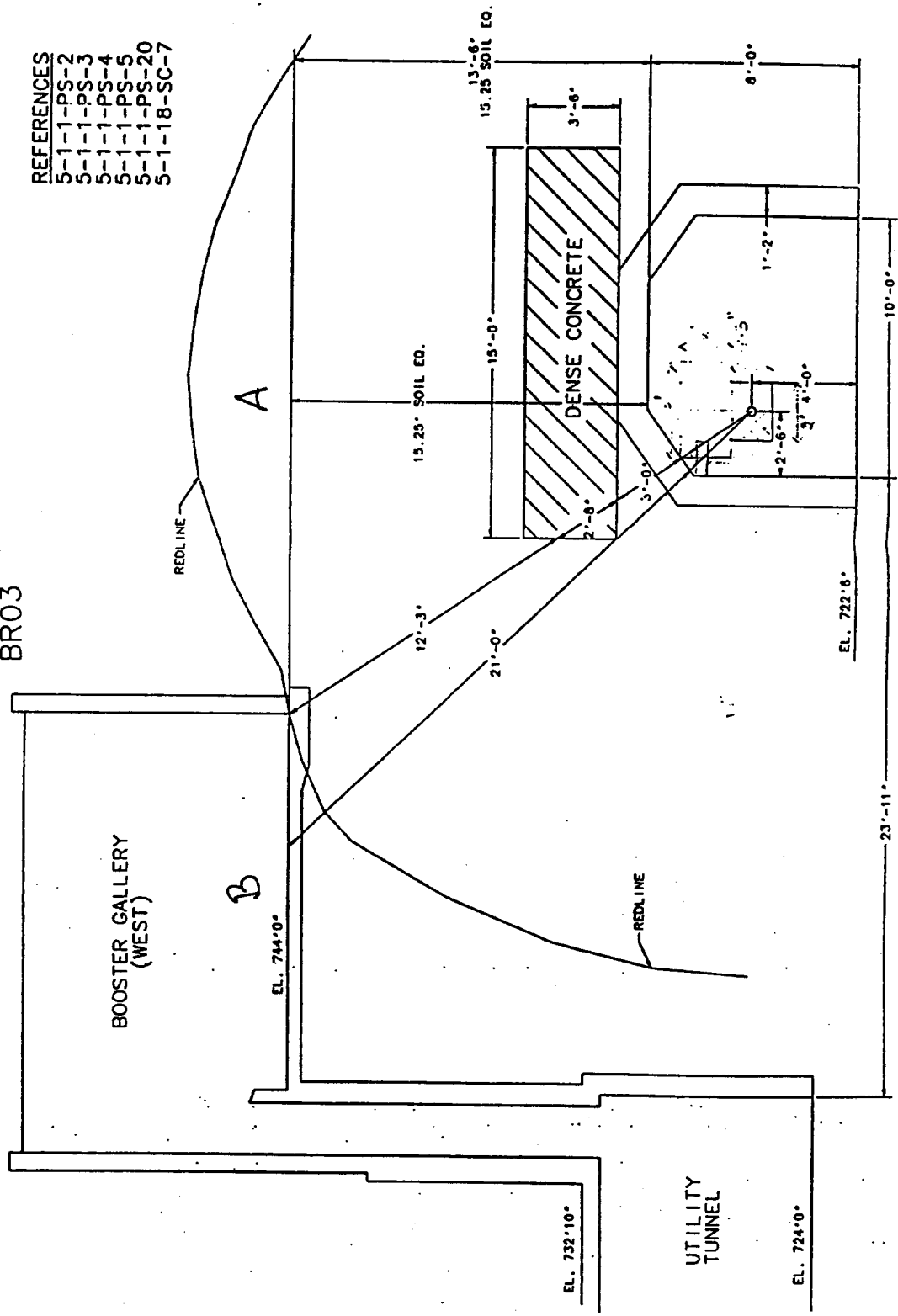

Fig. 2

L-3 SEPTUM /  
UTILITY TUNNEL  
BR03

ITEM	PART NO.	DESCRIPTION OR SIZE	QTY
PARTS LIST			
1	2	CONCRETE	2-3
2	2	WOOD	2-3
3	2	WOOD	2-3
NOTES			
1. SEE L-3 SEPTUM / UTILITY TUNNEL CROSS SECTION FOR DETAILS.			
2. SEE L-3 SEPTUM / UTILITY TUNNEL CROSS SECTION FOR DETAILS.			
3. SEE L-3 SEPTUM / UTILITY TUNNEL CROSS SECTION FOR DETAILS.			
4. SEE L-3 SEPTUM / UTILITY TUNNEL CROSS SECTION FOR DETAILS.			

FERMI NATIONAL ACCELERATOR LABORATORY  
 UNITED STATES DEPARTMENT OF ENERGY  
 BOOSTER SHIELDING  
 TUNNEL CROSS SECTION  
 3 SEPTUM / UTILITY TUNNEL  
 ENCL.

SCALE: 1/2" = 1'

CROSS SECTION OF GEOMETRY FOR CONSTANT X = 6.00 CM  
 FROM Y = 0.00 TO Y = 300.00 CM (VERTICAL) AND  
 FROM Z = 0.00 TO Z = 5000.00 CM (HORIZONTAL)

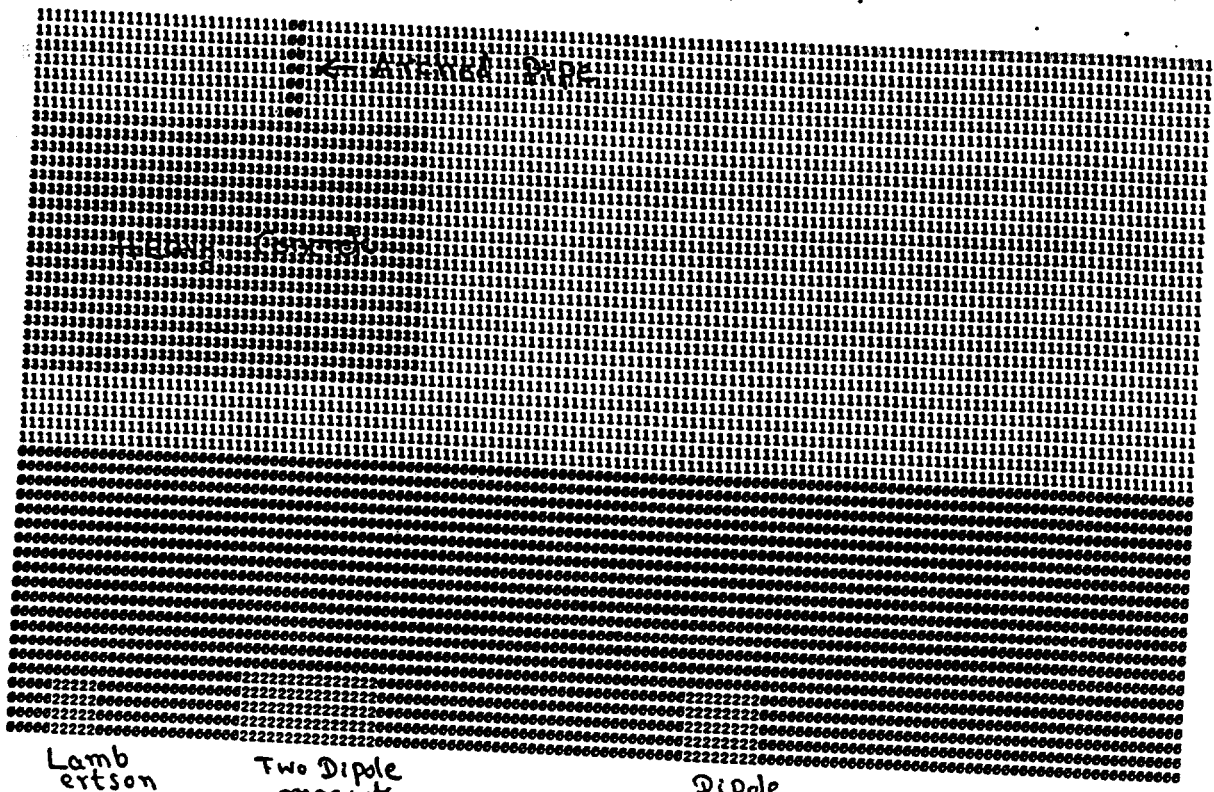
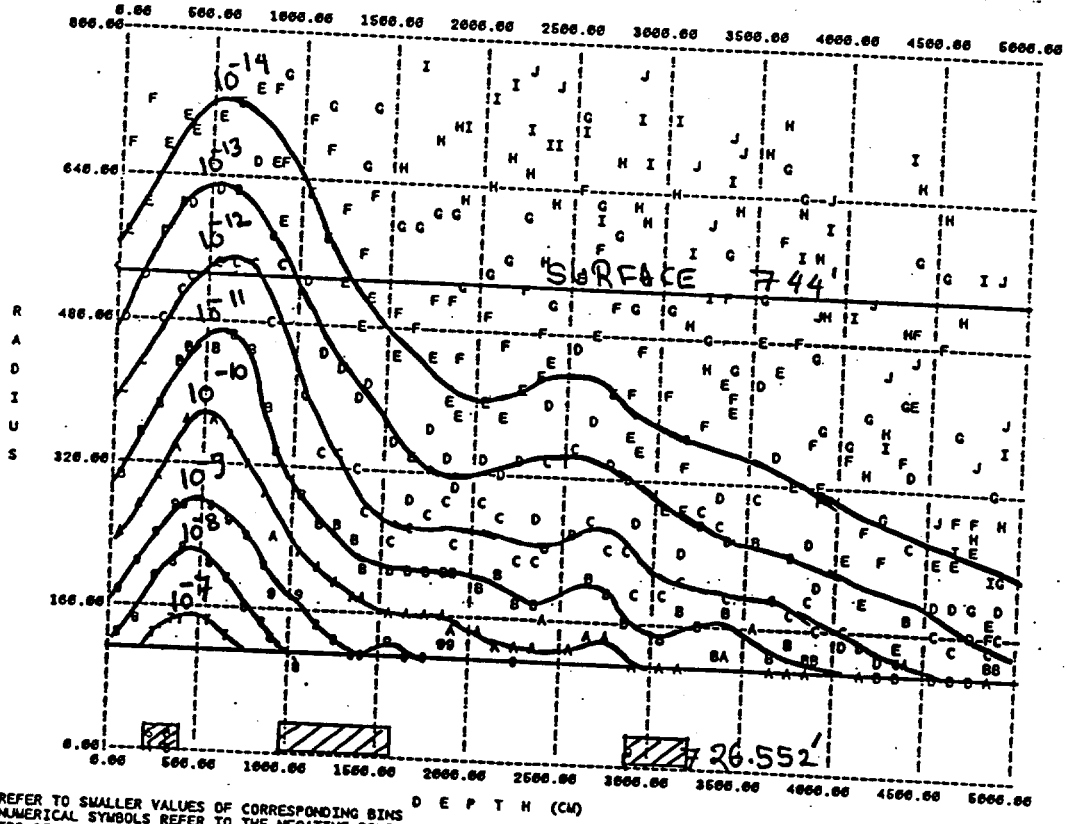

Fig. 3

CONTOURS OF EQUAL STAR DENSITY (STARS/CM<sup>3</sup>·INC.PTCLE)  
 CONTOURS ARE SHOWN FOR INTEGRAL POWERS OF 10



R-LABELS REFER TO SMALLER VALUES OF CORRESPONDING BINS  
 LEGEND: NUMERICAL SYMBOLS REFER TO THE NEGATIVE POWER OF 10 OF THE STAR(ENERGY) DENSITY E.C. S REFERS TO THE 10<sup>-5</sup> CONTOUR  
 OTHER POWERS OF 10 (SYMBOLS): -10(A), -11(B), -12(C), -13(D), -14(E), -15(F), -16(G), -17(H), -18(I), -19(J)  
 1(Z), 2(Y), 3(X), 4(W), 5(V), 6(U), 7(T), 8(S), 9(R), 10(Q)

CROSS SECTION OF GEOMETRY FOR CONSTANT X = 0.00 CM  
 FROM Y = 0.00 TO Y = 300.00 CM (VERTICAL) AND  
 FROM Z = 0.00 TO Z = 5000.00 CM (HORIZONTAL)

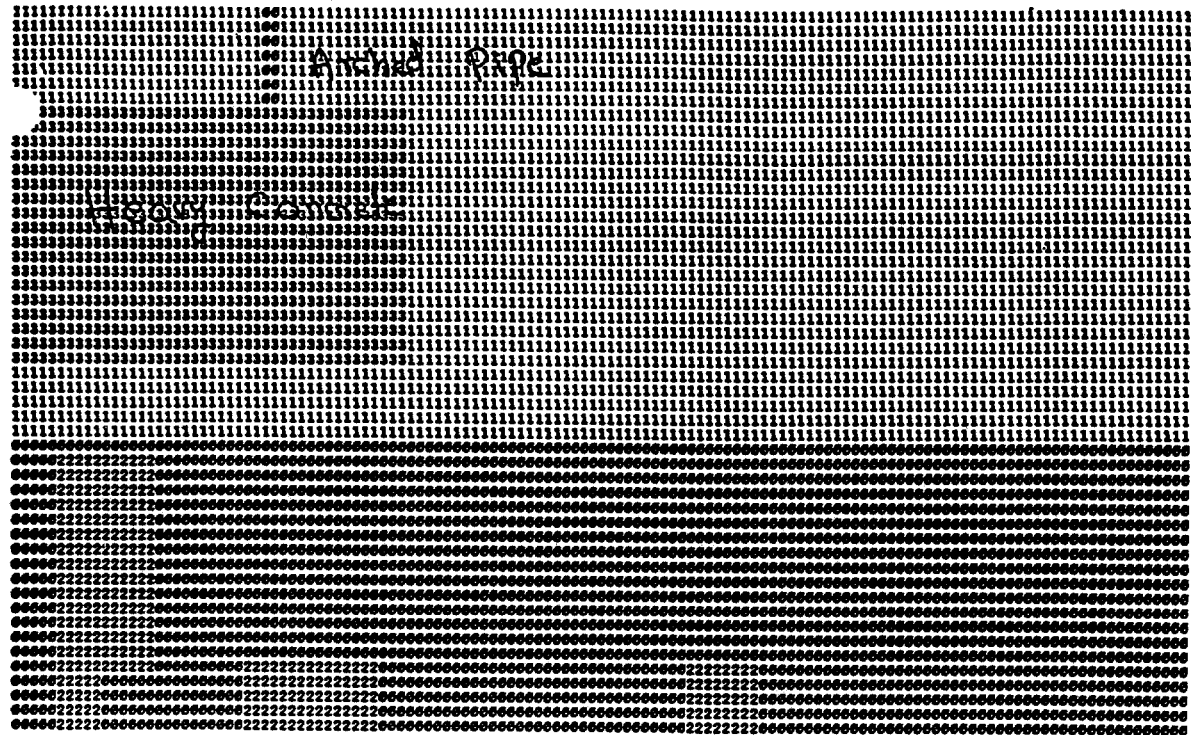

Lambertson Dipoles Dipole  
 8 GeV Beam line Tunnel. Fig. 4

CONTOURS OF EQUAL STAR DENSITY (STARS/CM<sup>3</sup>-INC.PTCLE)  
 CONTOURS ARE SHOWN FOR INTEGRAL POWERS OF 10

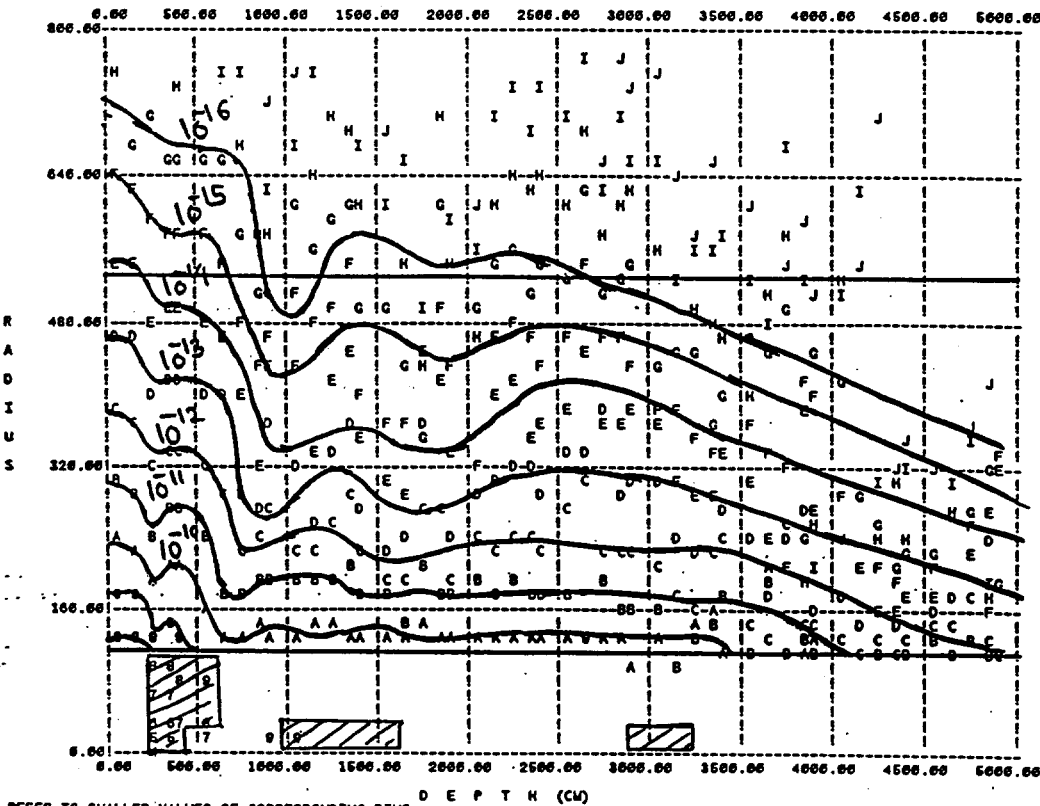

R-LABELS REFER TO SMALLER VALUES OF CORRESPONDING BINS  
 LEGEND: NUMERICAL SYMBOLS REFER TO THE NEGATIVE POWER OF 10 OF THE STAR(ENERGY) DENSITY E.G., 6 REFERS TO THE 10<sup>6</sup>-5 CONTOUR  
 OTHER POWERS OF 10(SYMBOLS) :-10(A), -11(B), -12(C), -13(D), -14(E), -15(F), -16(G), -17(H), -18(I), -19(J)  
 1(Z), 2(V), 3(X), 4(W), 5(V), 6(U), 7(T), 8(S), 9(R), 10(Q)

CROSS SECTION OF GEOMETRY FOR CONSTANT Z = 1.00 ft  
 FROM X = -4.00 TO X = 20.00 ft (VERTICAL) AND  
 FROM Y = 10.00 TO Y = -10.00 ft (HORIZONTAL)

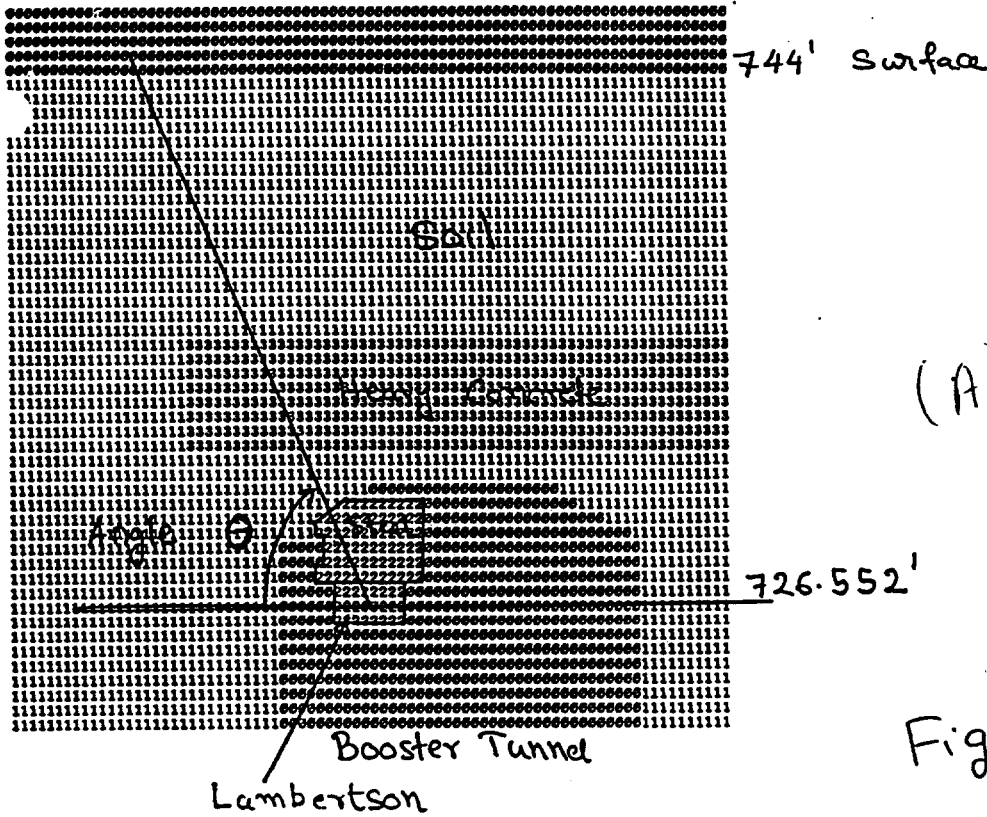

(A)

726.552'

Fig. 5

Equivalent Soil Thickness above the Booster to MI Extraction Lambertson (with 3.0ft steel shielding)

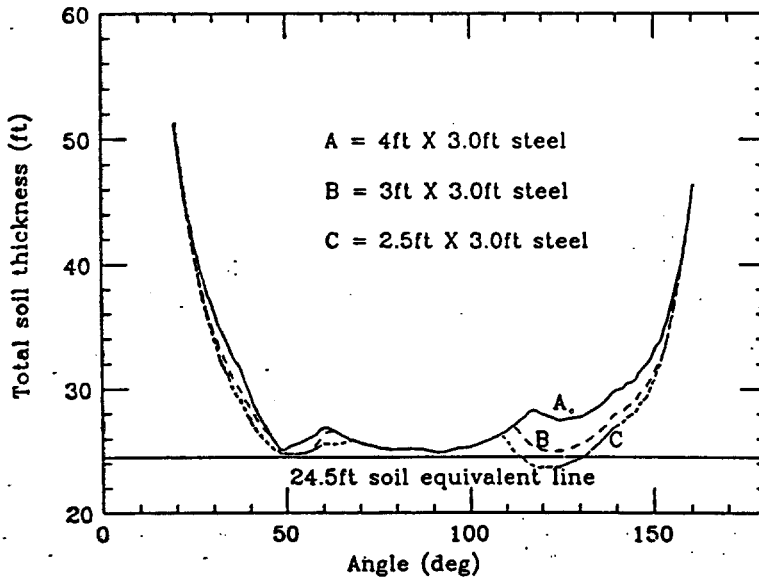

(B)

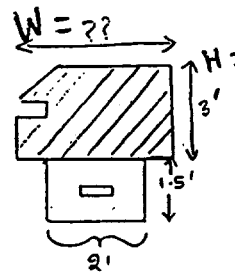

3.5ft thick heavy concrete buried in soil is assumed

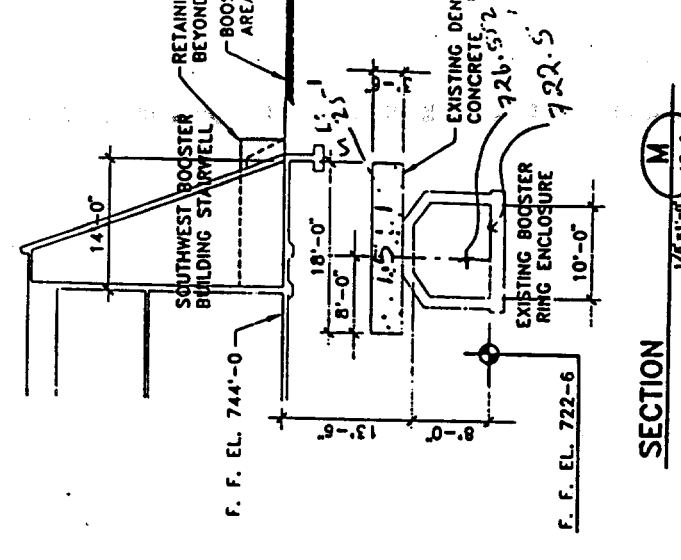
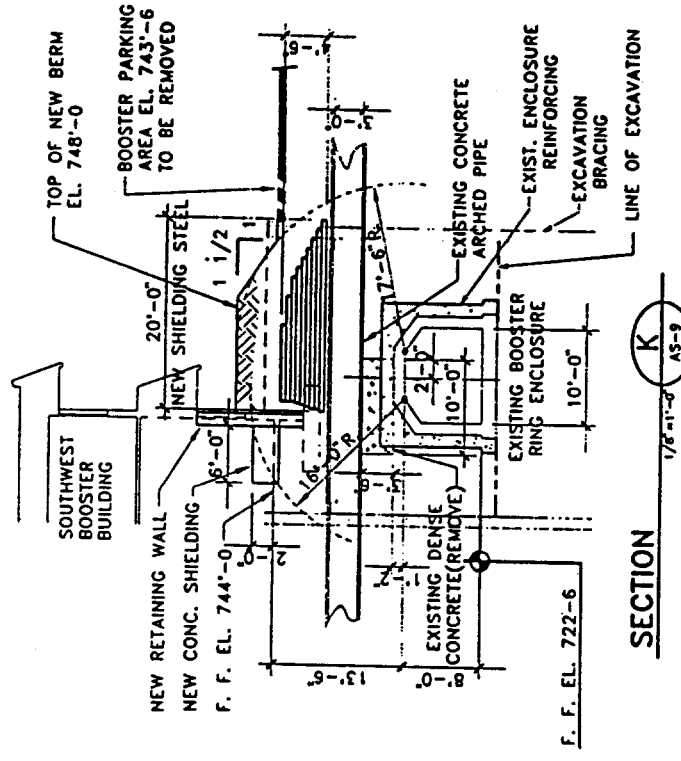
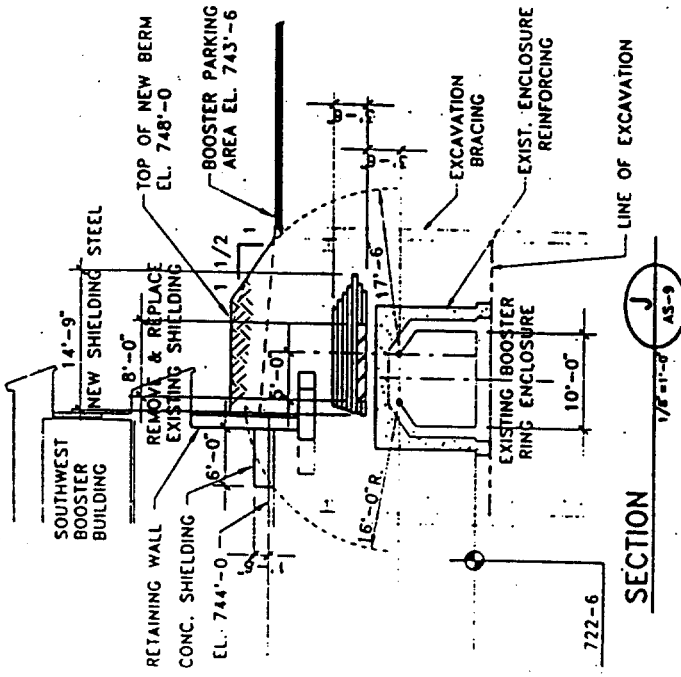
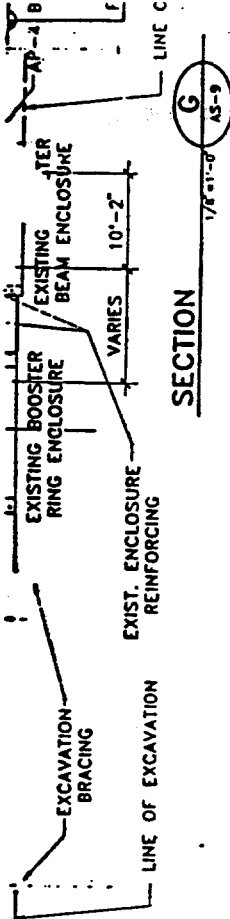
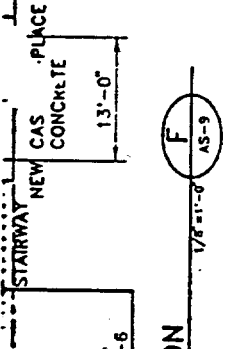
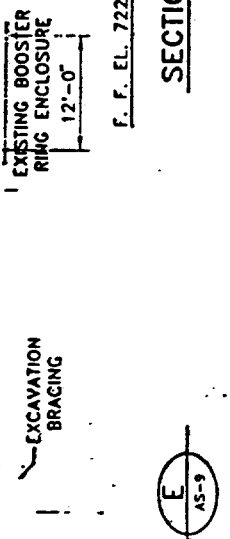
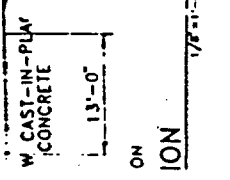

**DANIEL**  
LUMBER

2 - 21842300

DATE
JULY, 1992
JULY, 1992
JULY, 1992

DESIGNED	DATE
T. LACKOWSKI	
DRAWN	
J. HACKEMER, J. GEHARD	
CHECKED	
APPROVED	
SUBMITTED	

SCALE: 1/8" = 1'-0" SCALE

SECTION

FERMI NATIONAL ACCELERATOR  
UNITED STATES DEPARTMENT OF ENERGY

**FERMILAB MAIN**

8 GeV SECTIONS

DRAWING NO. 6-6-2 TITLE-1 A